

EA Sydney Division Nuclear Engineering Panel

**Nuclear Power Reactors and Hydrogen
Production**

Tony Irwin

15th July 2020

Opportunities for Process Heat

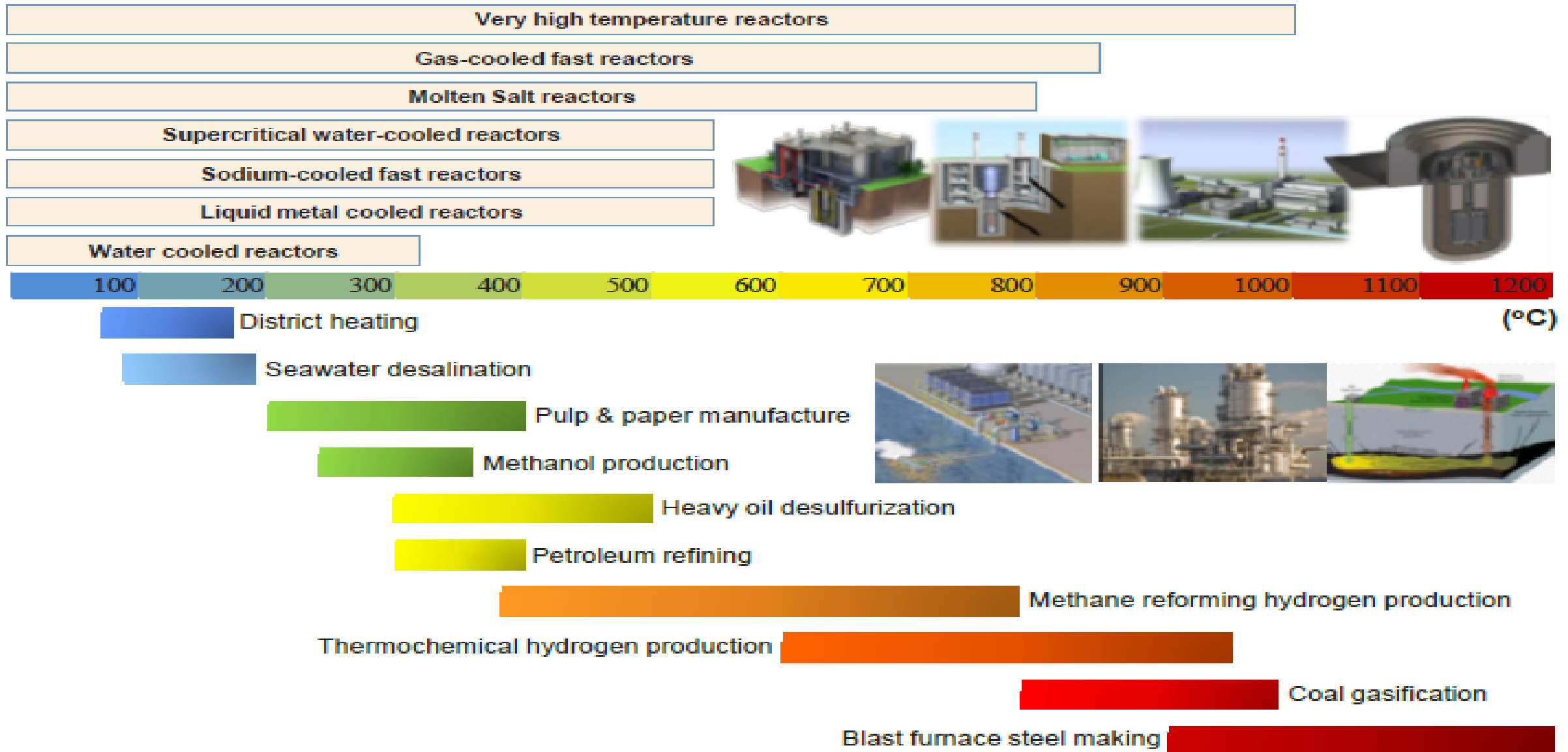

Nuclear Reactors for Hydrogen Production

Reactor Type	Outlet Temperature
Pressurised Water Reactor (PWR)	275°C - 325°C
Molten Salt Reactor (MSR)	600°C - 800°C
Very High Temperature Reactor (VHTR)	750°C - 1,000 °C

Temperatures of Electrolysis Technologies

Electrolysis Technology	Temperature Range
Alkaline electrolysis (AE)	50°C - 80°C
Proton Exchange Membrane (PEM)	20°C - 90°C
Solid Oxide Electrolysis Cell (SOE)	700°C – 1,000°C

Source: for electrolysis temperatures : CSIRO 2016 Cost Assessment of H₂ Production from PV and Electrolysis

Temperatures of Chemical Technologies

Chemical Technologies	Temperatures
Sulphur-Iodine	360°C / 850°C
Copper-chlorine	580°C
Hybrid Sulphur	80°C / 800°C

High Temperature Steam Electrolysis

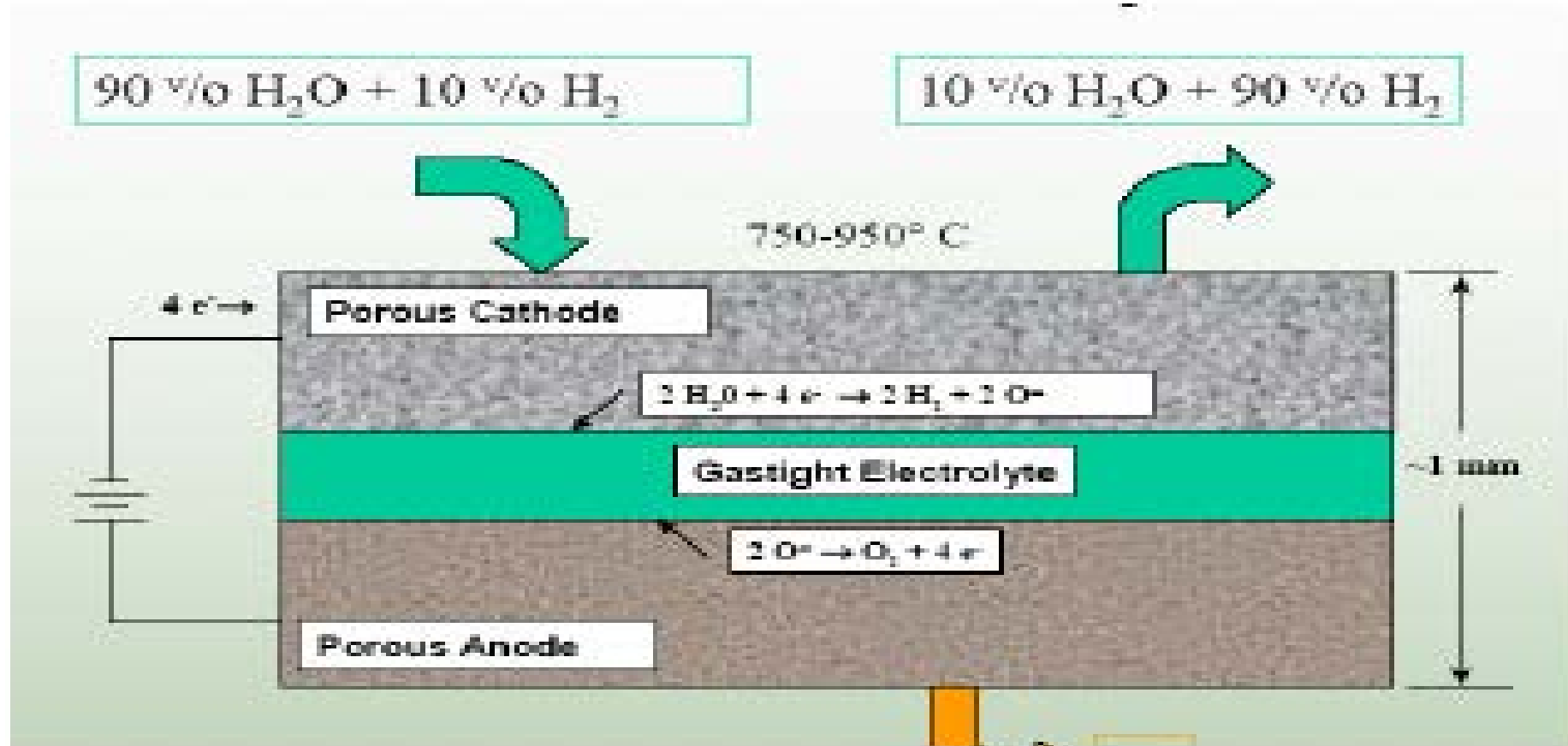

Solid oxide electrolyte.

More efficient than room temperature electrolysis because some of the energy is supplied as heat – operates at 750°C – 950°C

Countries actively developing: France (CEA), US (25 kW HTSE test facility at INL), China.

Nuclear Power and Hydrogen

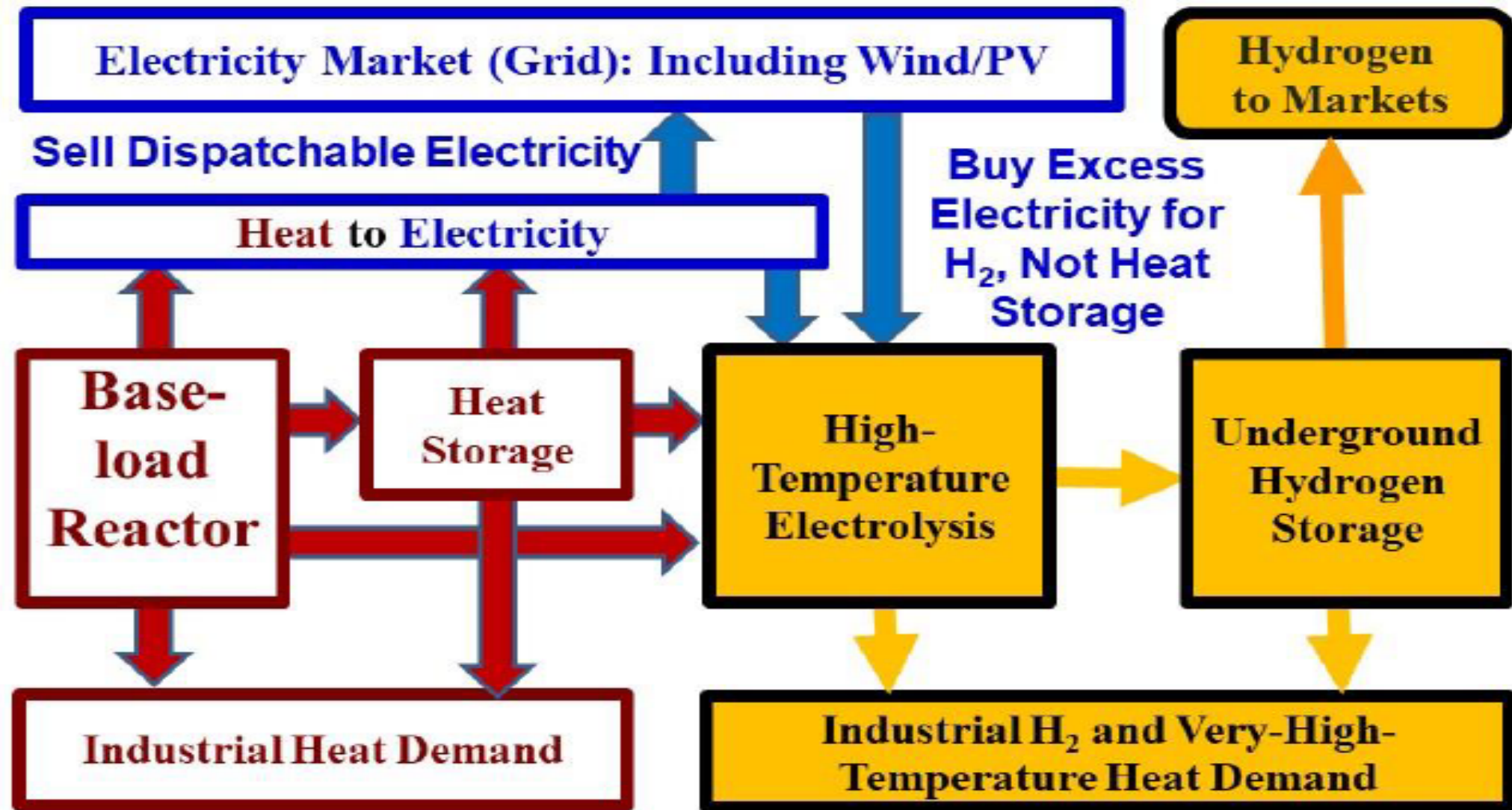

NICE Hydrogen webinar March 2020 – DOE H₂@Scale Initiative

Program Summary

Partners: Exelon & Nel Hydrogen, INL, NREL, ANL

Period: 36 months

Total budget: \$7.2 million

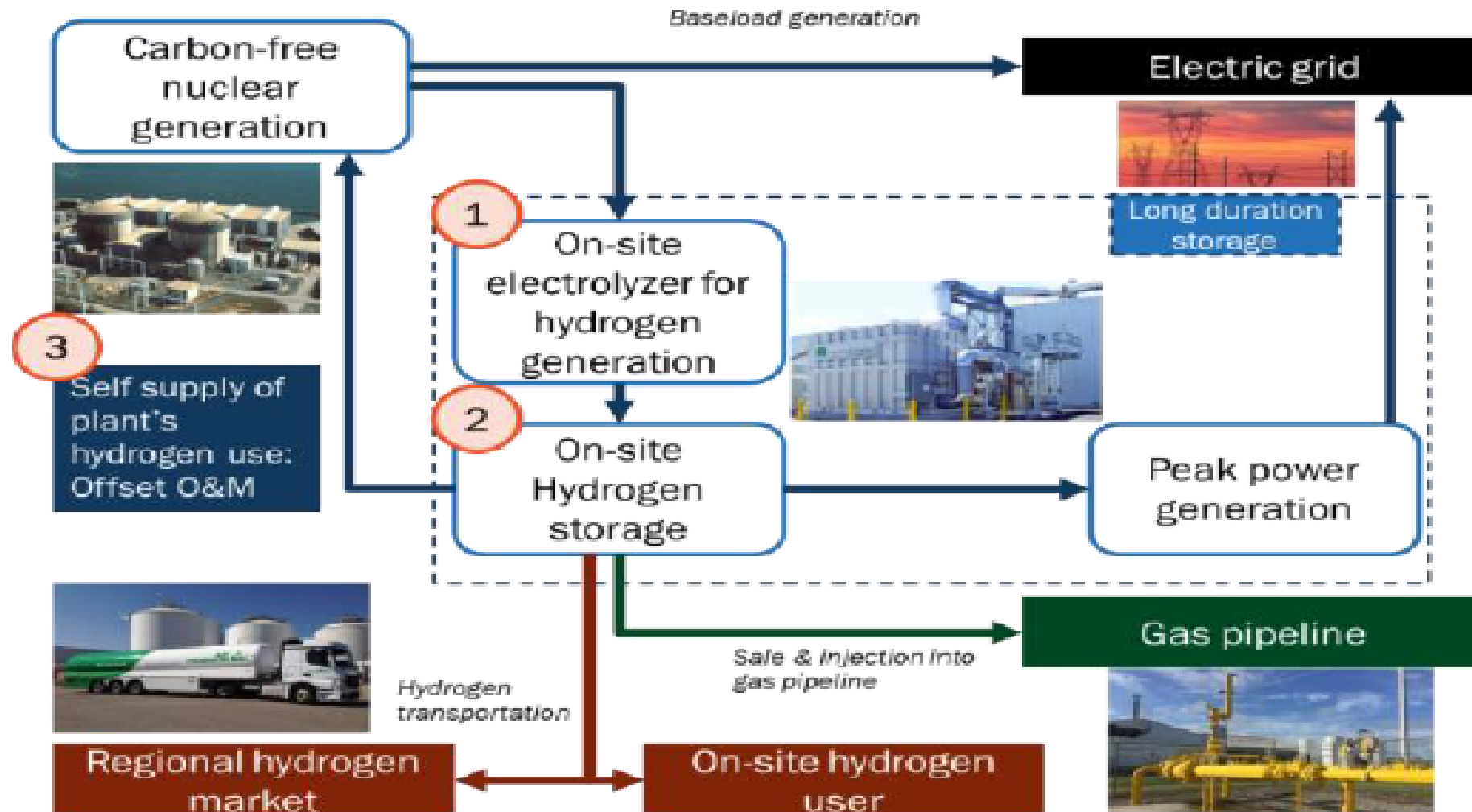

Recently Funded NE-Led Demonstration

FirstEnergy Solutions Corp., Xcel Energy, APS, INL

LWR Integrated Energy Systems Interface Technology Development & Demonstration
at Davis-Besse NPP in Ohio

- \$11.5M (\$9.2M DOE), announced September 2019
- 2 MW Containerized “Turn-Key” Electrolysis Test Skid helps reduce project risk
- 24 month project - operation and verification planned for 2022
- Onsite and offsite uses planned



- Ensure no adverse effects on the plant, grid, or skid.
- Control software will be able to modulate H₂ output based on input variables.
- Control software will interface with Programmable Logic Computer (PLC) on vendor supplied H₂skid.



NuScale Power (USA) 60 MWe power modules

Reactor Building

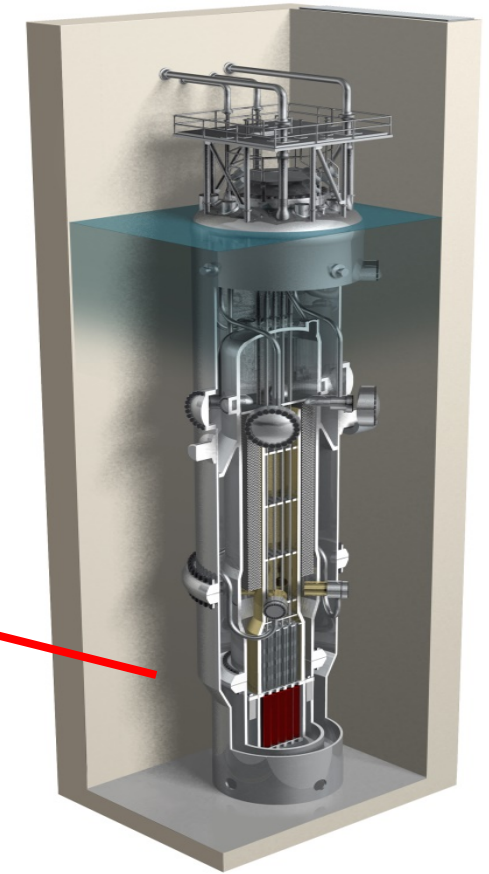
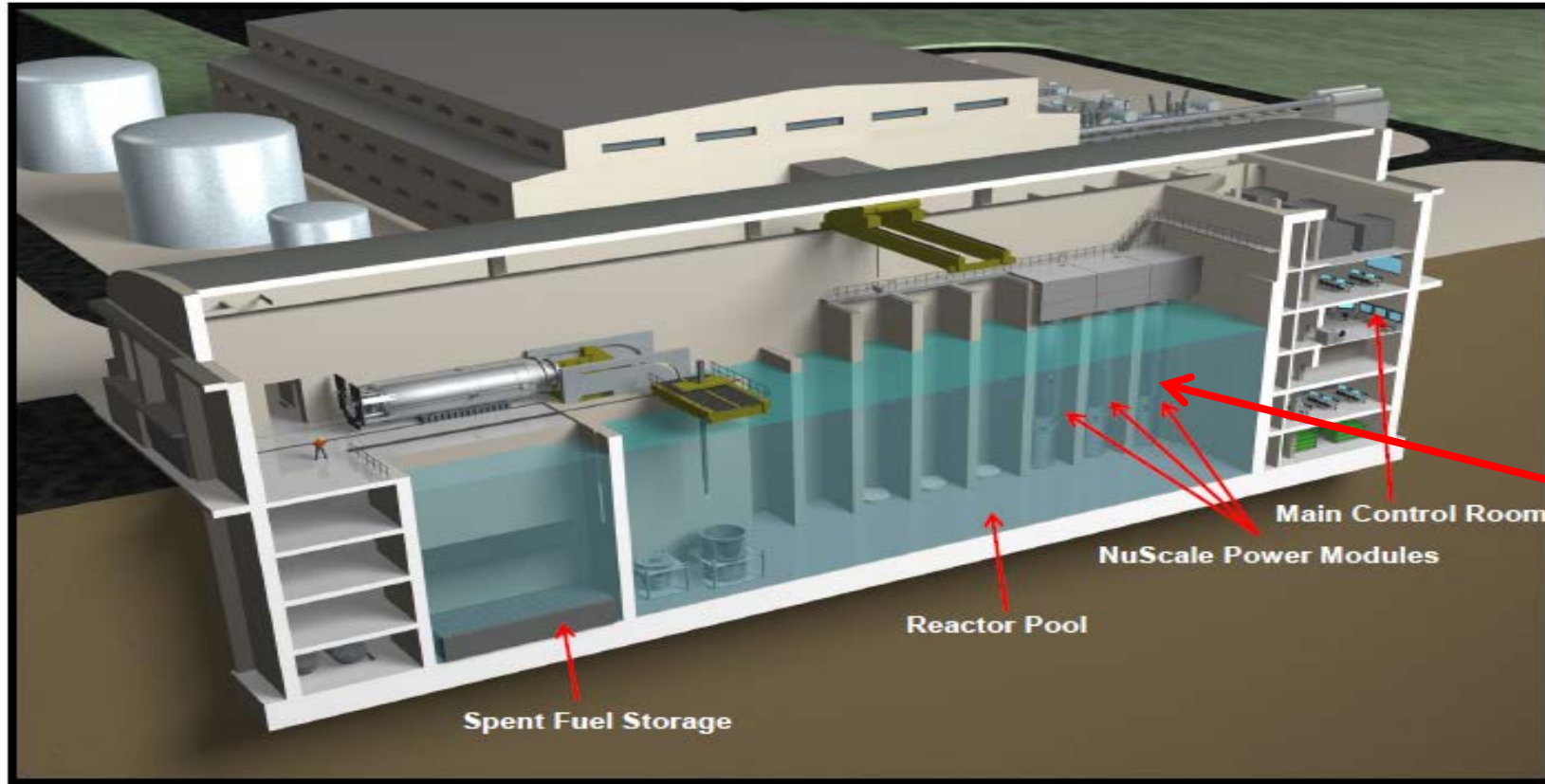

© NuScale Power, LLC. All Rights Reserved.

Main steam (3.5 MPa, 302°C) to turbine and HTSE. 1.15 MWe electrical power used to boost inlet temperature to 800°C.

Six module plant could produce 190 tonnes/day hydrogen

One module 1,310 kg/hr

Source: NuScale Power

Very-High-Temperature Reactor (VHTR)

Characteristics

- He coolant
- >900C outlet temperature
- 250 MWe
- Coated particle fuel in either pebble bed or prismatic fuel

Benefits

- Hydrogen production
- Process heat applications
- High degree of passive safety
- High thermal efficiency option

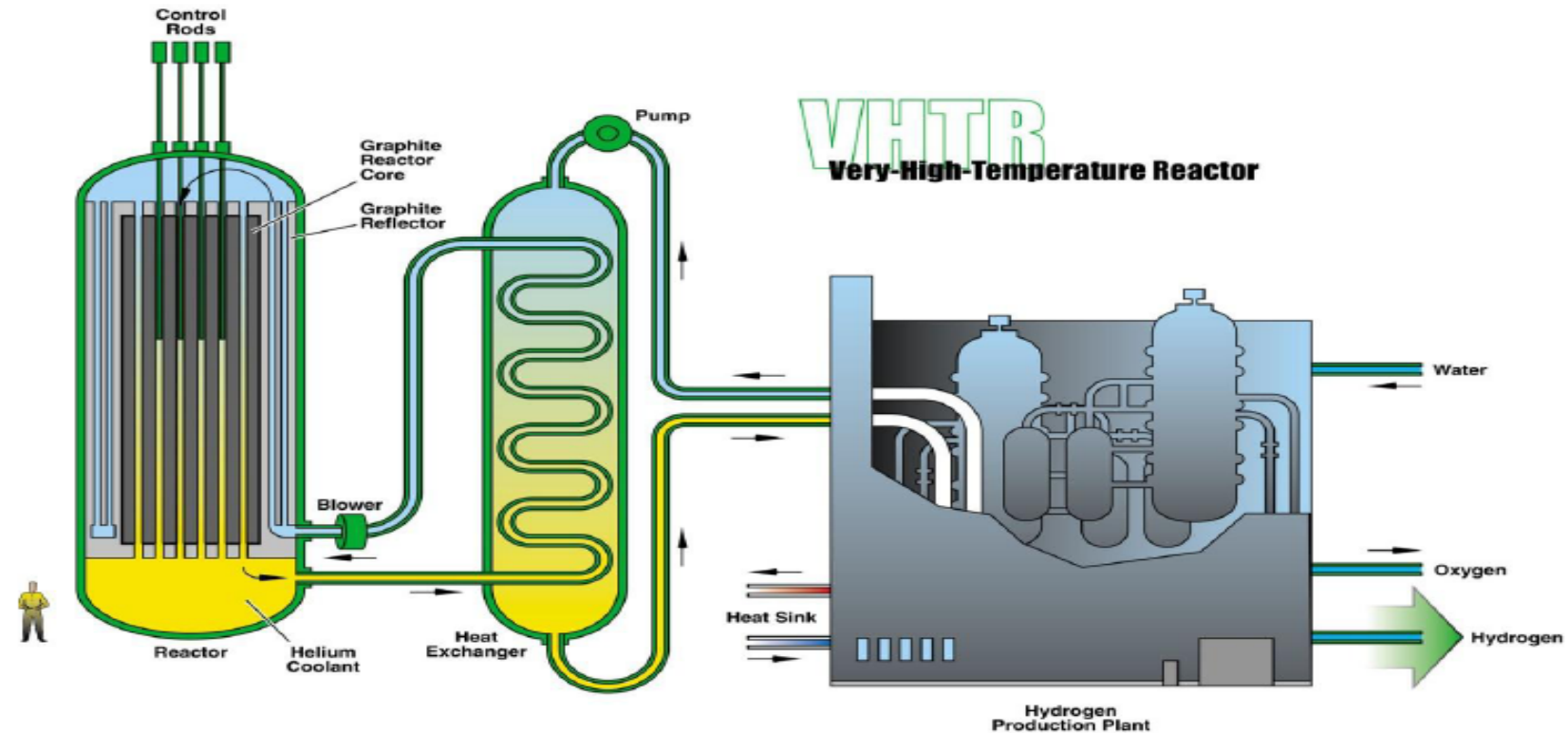

Inherent Safety Approach

- Ceramic fuel retains radioactive materials up to $\sim 2000^\circ\text{C}$

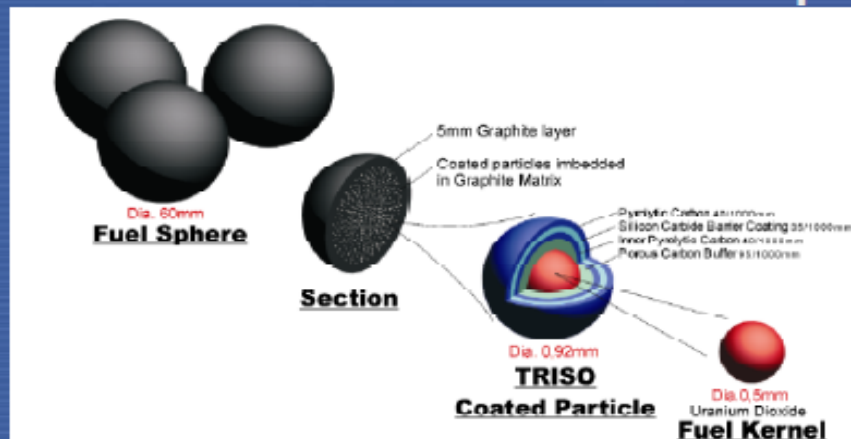

- Coated particles stable to beyond maximum accident temperatures

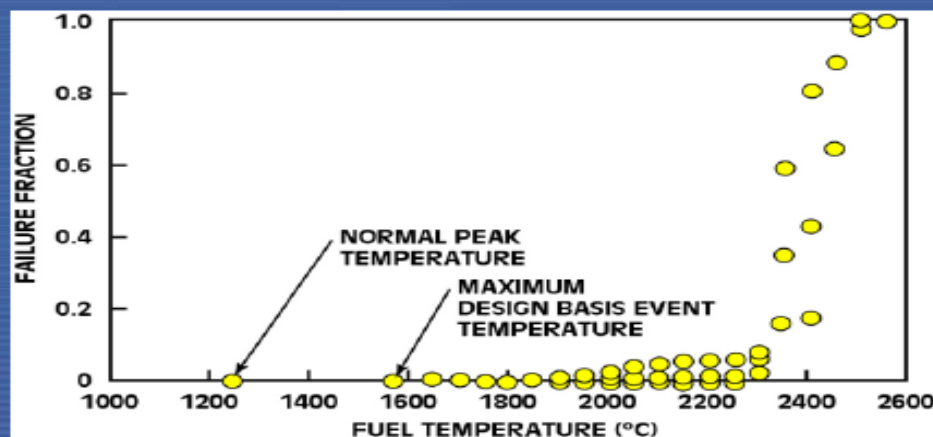

- Heat removed passively without primary coolant

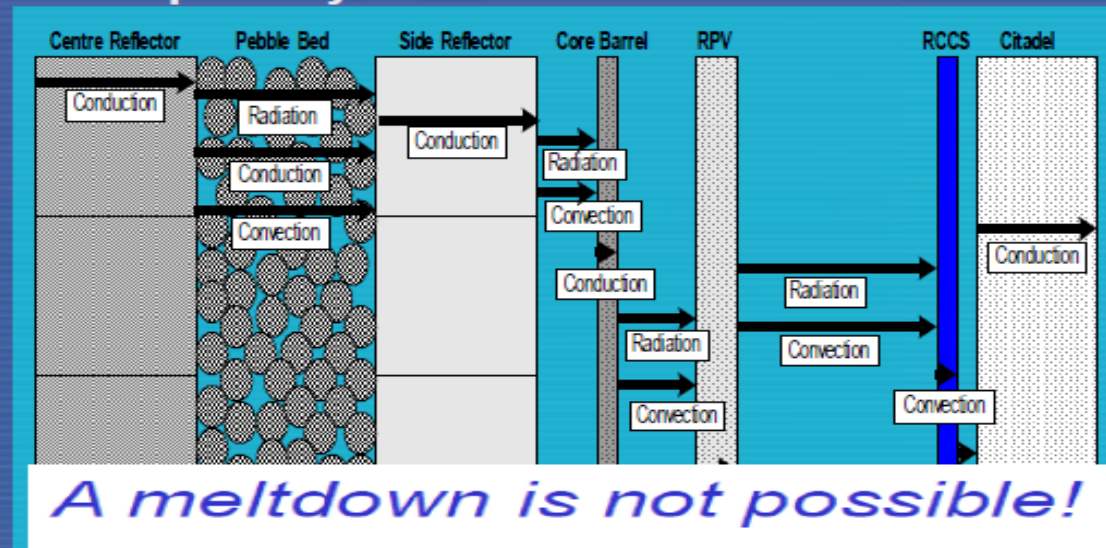

- Fuel temperatures remain below design limits during loss-of-cooling events

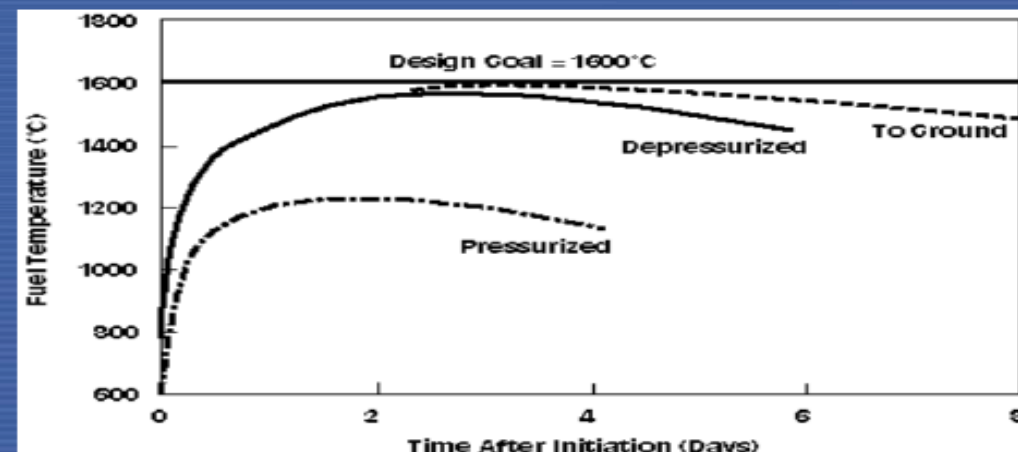

VHTR for Hydrogen Production

2017 Jan Gen IV Webinar

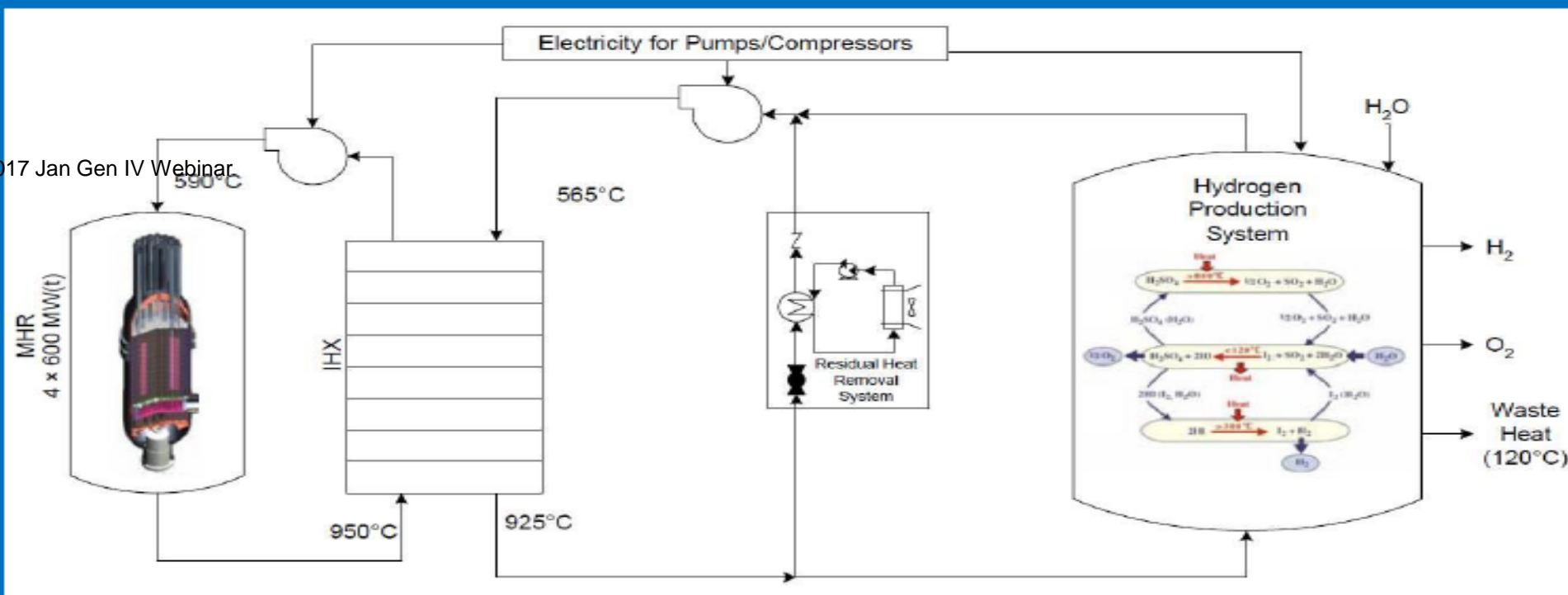

Source: "H₂-MHR Pre Conceptual Design Report: S-I Based Plant" [Richards 2006]

Sulphur-Iodine Process

Countries actively developing:

Japan, China, South Korea, India.

Status: Integrated System demonstration (China 1 Nm³/hr).

Also Japan 30l/hr

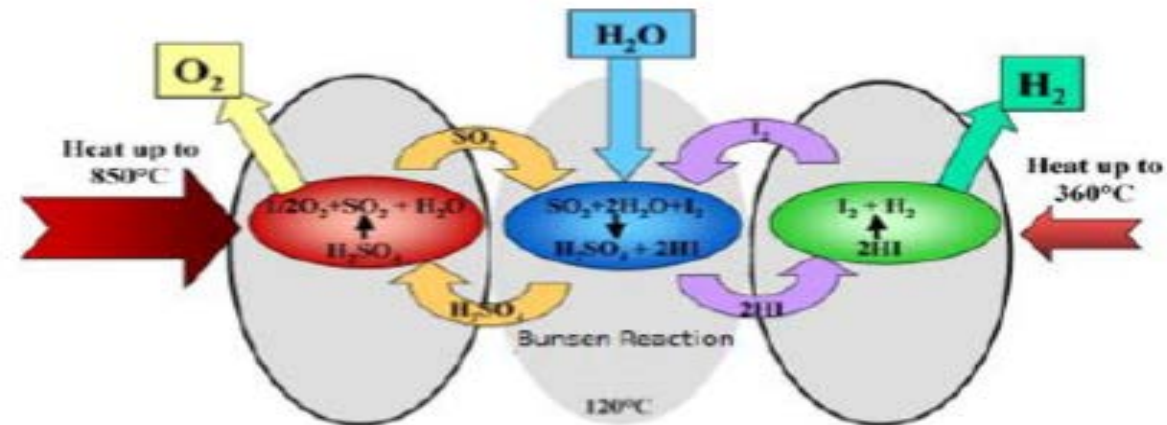

Terrestrial Energy Integral Molten Salt Reactor (IMSR)

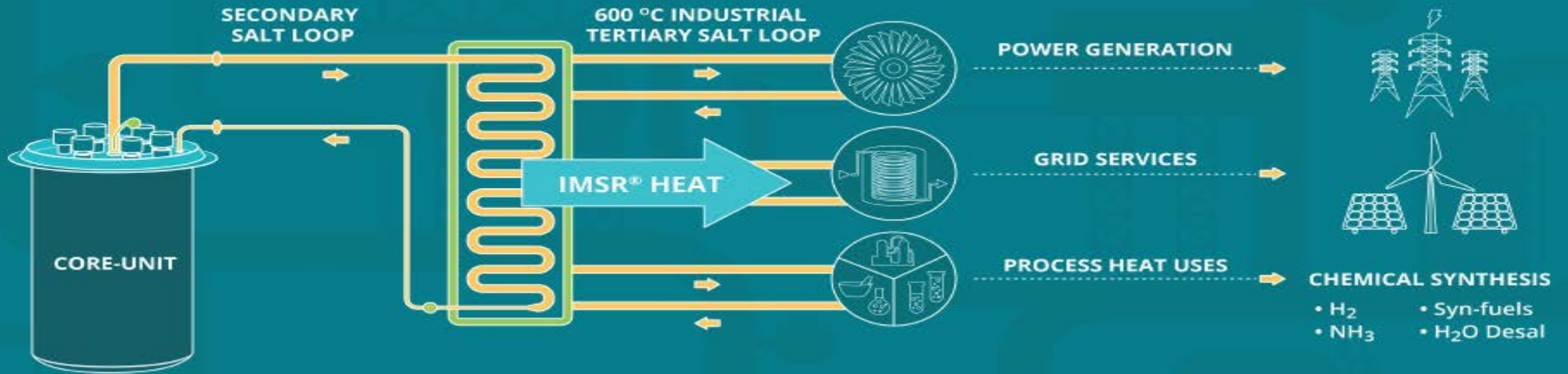

400 MWTh, 190 MWe, load following capable plus 600°C process heat

Build in 4 years, 24 hectare site, first deployment 2020's , looking at sites at Canadian National Laboratories and INL.

LCOE US\$50/MWhr

CNSC (Canadian Nuclear Safety Commission) Phase 1 design review completed, Phase 2 in progress

26 June 2017 – GAIN (Gateway for Accelerated Innovation in Nuclear) award from US-DOE

Developing hydrogen production using hybrid Sulphur process

The Future: Microreactor Powered Hydrogen Fueling Station

Notional Specs*

MW Total (15 MW modules)	60
kg / day trucks	50
kWh / kg hydrogen generation	50
kWh / truck / day	2500
trucks / station / day	576
fueling positions	~12

*not associated with images



Image courtesy of Nikola Motor Company

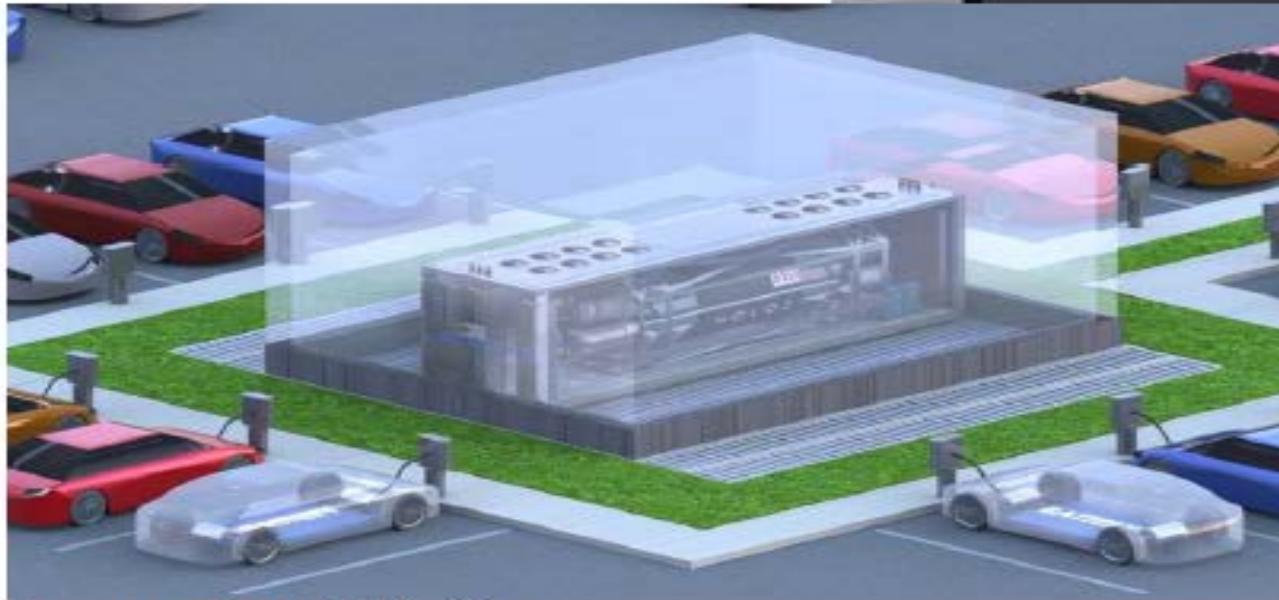

Image courtesy of HoloGen

HOLOS Microreactor

VHTR TRISO fuel in sealed cartridges, helium or CO₂ coolant to Brayton power conversion gas turbine.

Heat and electricity for electrolyser.

Conclusions

Nuclear Power is the only low emissions, reliable technology that can provide substantial quantities of process heat.

A change to low emissions heat for industrial processes will be an essential part of Australia's drive to low emissions by 2050.

The current fleet of nuclear power plants could use surplus electricity to produce hydrogen

Advanced nuclear plants coupled with higher temperature more efficient hydrogen production technology will be a cost-effective source of hydrogen with low emissions and minimum land requirements.